

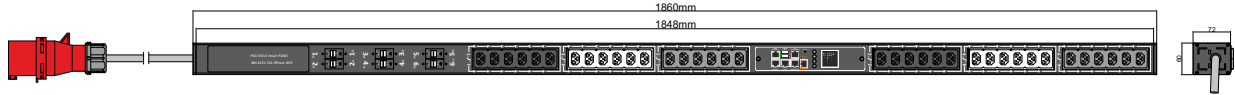



IEXCBPOMS503632A3PV



FEATURES	
Technology	POMS (Per Outlet Metering & Switching)
Energy Metering	Voltage(V), Current(A), Active Power(W), Apparent Power (VA), Reactive Power (var), PF, Frequency(Hz), kWh
Metering per Input Line	Yes (Branch Circuit and Total Current) Accuracy 1%
Metering per Output Receptacle	Yes Accuracy 1,5%
Remote Outlet Switching	Yes (Bistable Latching Relays)
Ethernet Port	2 Gigabit Ethernet ports to acces the PDU from 2 different networks
Networking Protocols	DHCP, IPv4 and IPv6, DNS, http / https, SSHv.2, SNMP v1 / v2c / v3, SNMP TRAPS / SETS / GETS, SMTP, Modbus , Telnet, TCP, RADIUS, Syslog, TLS 1.2, SNTP, ARP, ICMP, ICMPv6, UDP, NDP
PDU Cascading	16 PDUs
Power Share	Yes
Network Controller	Replaceable Hot Swapable controller with 4 button OLED display
Residual Current Monitoring	No (optional)
Rack Acces Control	Compatible with DCIM solutions
USB Ports	2 USB A ports WiFi networking,webcam,PDU configuration and mobile interface
Environmental Sensors	All in one Temperature and Humidity sensor with 2 digital inputs (for connect air flow, door sensor, water leak, smoke detector and Vibration sensor) plug and play bus allows to connect 8 EMD devices in one PDU
INPUT	
Plug	IEC60309 3P+N+E 6h 32A 380-415V
Lead Length	3 meter
Cable Type	H07RN-F5G4.0 mm ²
Max. Input Load	32A
Rated Input Voltage	380-415V three phase
Frequency	50-60Hz
Power Capacity	22.1kW
OUTPUT	
Rated Output Voltage	190-250V Single phase
Output Types	36 IEX (C13/C19) combo with LED (Max rate 16A) EN61984+UL498 certified
Overload Protection	(6) 1 Pole Carling 16A L31-X1-00-445-H62-D3
CHASSIS	
Dimensions (W x D x H)	1860 x 60 x 72 mm
Color	RAL 9004 black powder coat
Mounting Options	4 mounting options (see page 2)
Required Torque for Mounting Screws	≥2.54N·m (25.9kgf·cm or 22.4 in·lbs)
OPERATING ENVIRONMENT	
Temperature Range	0° to 60° C (30° to 140° F)
Humidity	0 - 95 %
Elevation	0 - 4000 Meters
CONFORMANCE	
IEC 62368-1 (Third Edition)	
   	

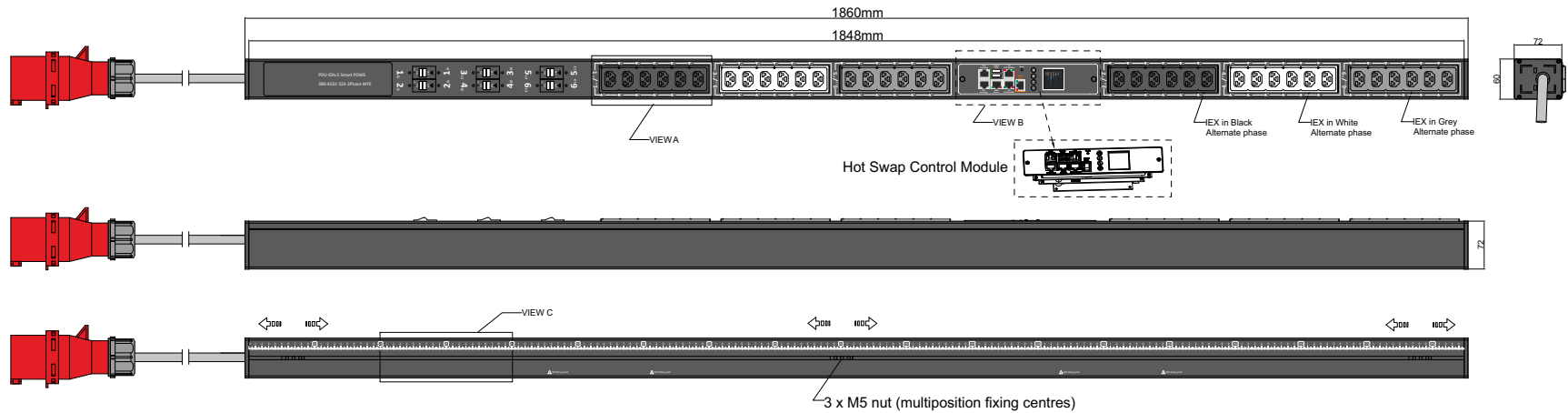
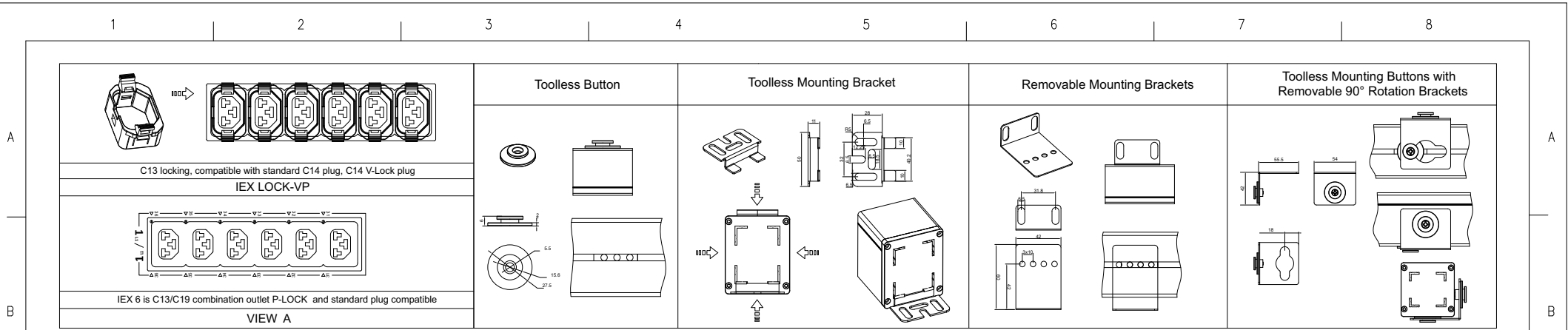

VIEW B:

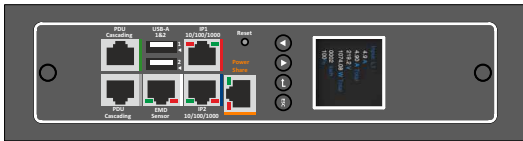

VIEW C:

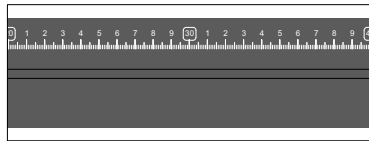

Chassis Color	Code
Black	Standard color
White	W
Red	R
Blue	A
Green	G
Orange	O
Grey	GY
Yellow	Y

POMS Series Inlet Power Monitoring Per Outlet Monitoring & Switching Environmental Monitoring	OUTPUT (12) IEX (C13/C19) combo with LED Black (Max rate 16A) (12) IEX (C13/C19) combo with LED White (Max rate 16A) (12) IEX (C13/C19) combo with LED Grey (Max rate 16A)	OPERATING TEMPERATURE 0° to 60°C
	INPUT 380-415VAC 32A 50HZ IEC60309 32A 3P+N+E Plug 3m H07RN-F5G4mm ² Power Lead	BRANCH CIRCUITS (6) 1 Pole Carling 16A L31-X1-00-445-H62-D3

DRAWING TYPE		IEXCBPOMS503632A3PV	
 (NO PERMISSION, NO CHANGING)		Housing	Aluminium
unit=mm TECHNICAL STANDARD IT11; NO RUST NO FLAW ON THE SURFACE			Black Powder Coating
FILLET R0.5 ANGLE ±0.5° FIRST ANGLE			RAL9004
		DATE 07-06-2021	

- Low cost locking solution at both ends
- Different colors available
- Patented IEX locking system
- Locking sleeve for C13 and C19 plugs
- VDE, UL approved

IEX PATENTED LOCKING SOCKET - POWER CORD SOLUTION



C14 - C13 Sleeve
H05VV-F3G1 mm²

Color	0,5M	1M	2M
Black	✓	✓	✓
Red	✓	✓	✓
Blue	✓	✓	✓

C14PLOCK - C13 Sleeve
H05VV-F3G1 mm²

Color	0,5M	1M	2M
Black	✓	✓	✓
Red	✓	✓	✓
Blue	✓	✓	✓

C20PLOCK - C19 Sleeve
H05VV-F3G1,5 mm²



Color	1M	2M
Black	✓	✓
Red	✓	✓
Blue	✓	✓

C20PLOCK - C13 Sleeve
H05VV-F3G1 mm²

Color	1M	2M
Black	✓	✓
Red	✓	✓
Blue	✓	✓

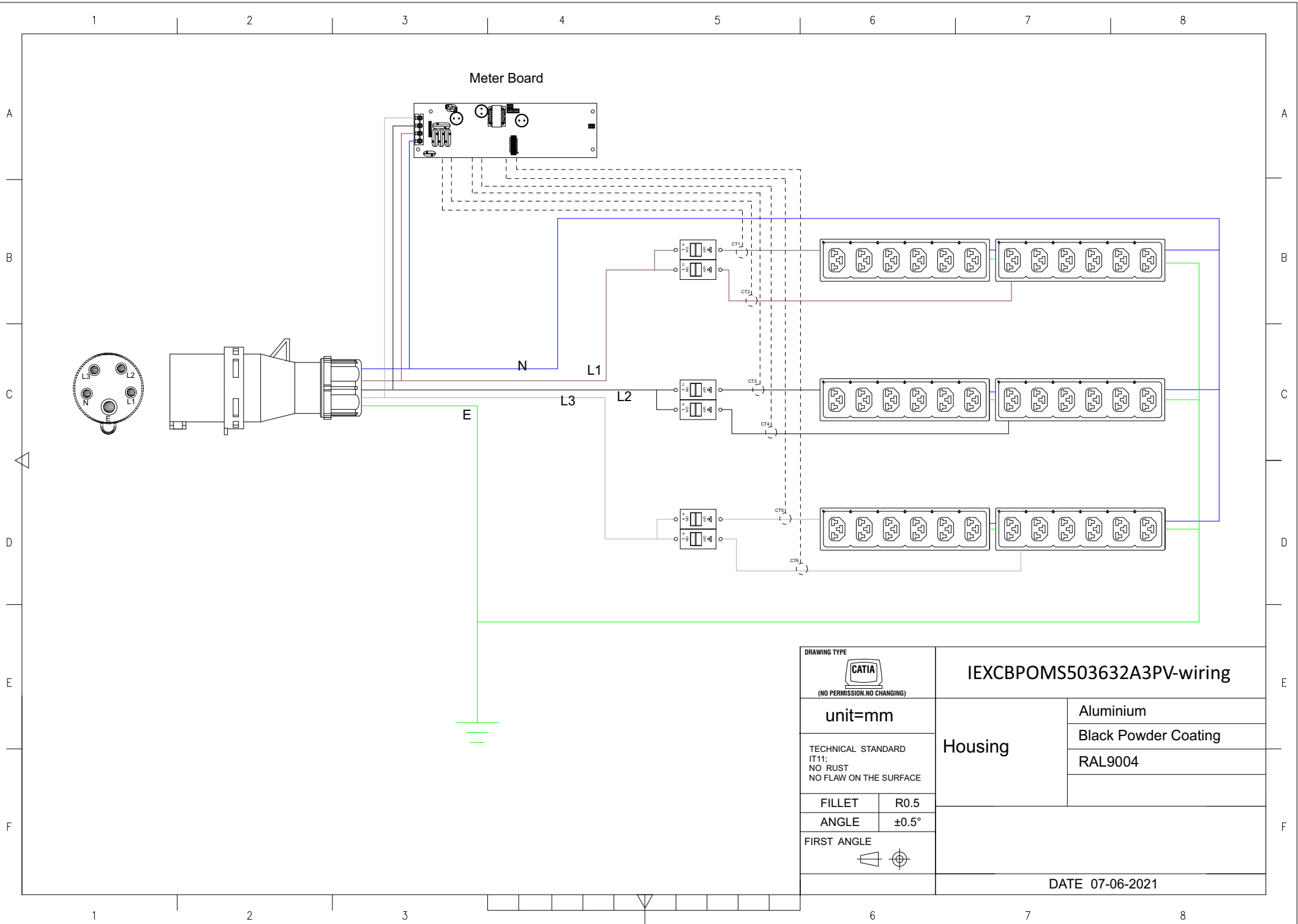
Meter Board



DRAWING TYPE		IEXCBPOMS503632A3PV-wiring	
 (NO PERMISSION.NO CHANGING)		Housing	Aluminium
unit=mm			Black Powder Coating
TECHNICAL STANDARD IT11: NO RUST NO FLAW ON THE SURFACE			RAL9004
FILLET	R0.5		
ANGLE	±0.5°		
FIRST ANGLE			
			
		DATE 07-06-2021	